

5-100525-9 ✓ ACTIVE

Z-PACK | Z-PACK 2mm HM

TE Internal #: 5-100525-9

Backplane Coding Keys, Plug, Coding Key Number 3467, Z-PACK
2mm HM

[View on TE.com >](#)



Connectors > PCB Connectors > Backplane Connectors > Backplane Coding Keys

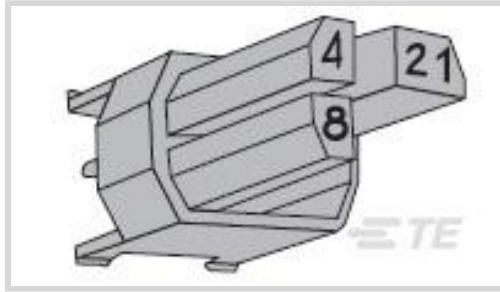

Applied to Connector Style: **Plug**

Coding Key Number: **3467**

Features

Body Features

Coding Key Color	Slate Gray
------------------	------------

Usage Conditions

Compatible With Backplane Connector Type	Type A, Type D, Type L, Type M
Applied to Connector Style	Plug

Packaging Features

Packaging Quantity	500
Packaging Method	Bag

Other

Coding Key Number	3467
-------------------	------

Product Compliance

[For compliance documentation, visit the product page on TE.com>](#)

EU RoHS Directive 2011/65/EU	Compliant
EU ELV Directive 2000/53/EC	Compliant
China RoHS 2 Directive MIIT Order No 32, 2016	No Restricted Materials Above Threshold
EU REACH Regulation (EC) No. 1907/2006	Current ECHA Candidate List: JUNE 2022 (224) Candidate List Declared Against: JUL 2021 (219) Does not contain REACH SVHC
Halogen Content	Low Halogen - Br, Cl, F, I < 900 ppm per homogenous material. Also BFR/CFR/PVC Free

Solder Process Capability

Not applicable for solder process capability

Product Compliance Disclaimer

This information is provided based on reasonable inquiry of our suppliers and represents our current actual knowledge based on the information they provided. This information is subject to change. The part numbers that TE has identified as EU RoHS compliant have a maximum concentration of 0.1% by weight in homogenous materials for lead, hexavalent chromium, mercury, PBB, PBDE, DBP, BBP, DEHP, DIBP, and 0.01% for cadmium, or qualify for an exemption to these limits as defined in the Annexes of Directive 2011/65/EU (RoHS2). Finished electrical and electronic equipment products will be CE marked as required by Directive 2011/65/EU. Components may not be CE marked. Additionally, the part numbers that TE has identified as EU ELV compliant have a maximum concentration of 0.1% by weight in homogenous materials for lead, hexavalent chromium, and mercury, and 0.01% for cadmium, or qualify for an exemption to these limits as defined in the Annexes of Directive 2000/53/EC (ELV). Regarding the REACH Regulation, the information TE provides on SVHC in articles for this part number is based on the latest European Chemicals Agency (ECHA) 'Guidance on requirements for substances in articles' posted at this URL: <https://echa.europa.eu/guidance-documents/guidance-on-reach>

Compatible Parts

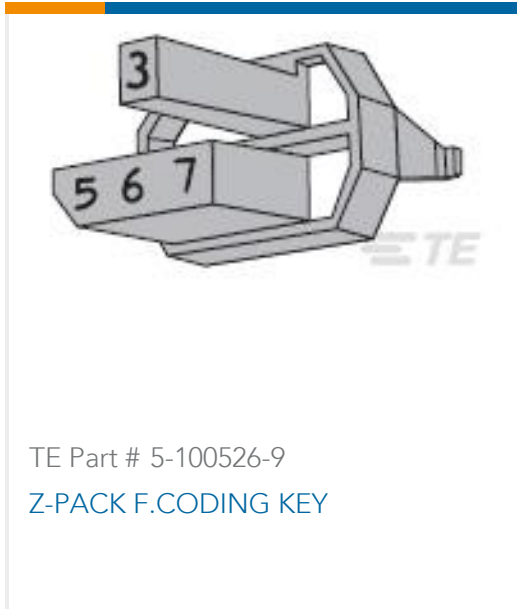

Also in the Series | Z-PACK 2mm HM

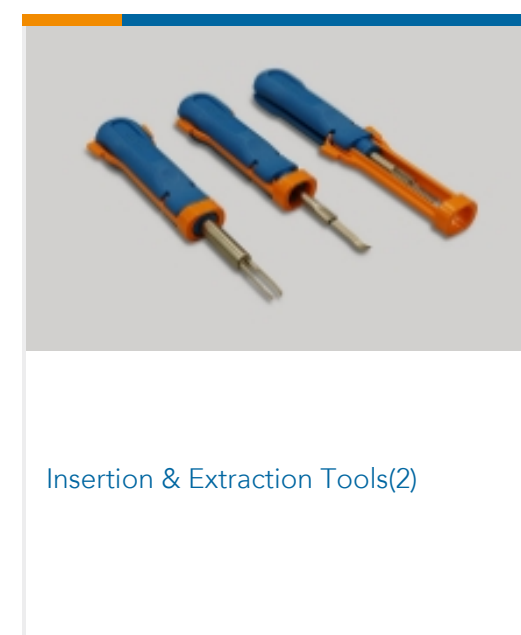
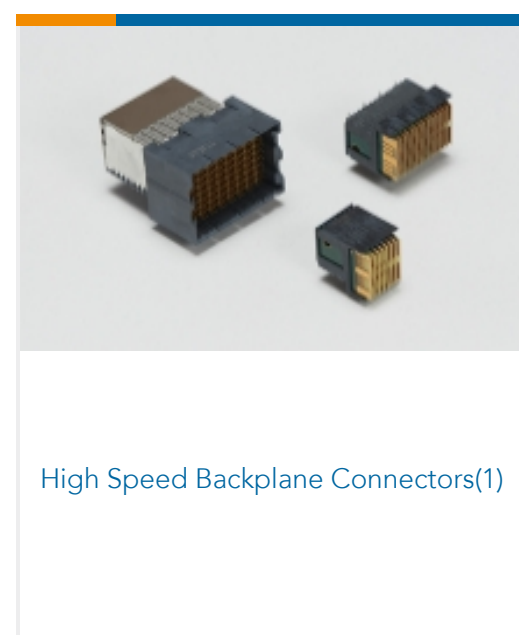
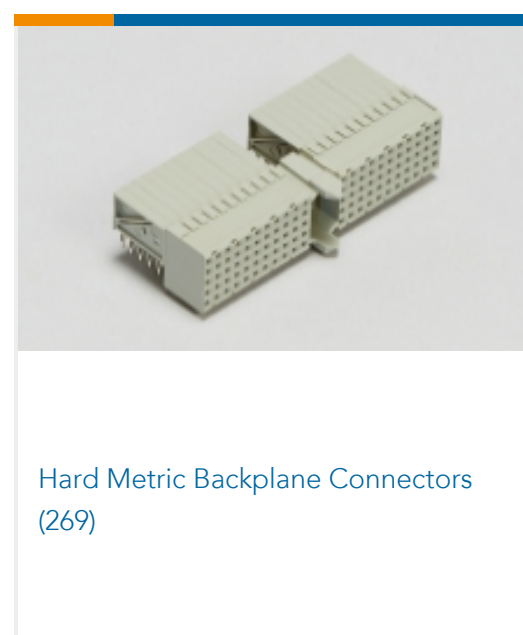
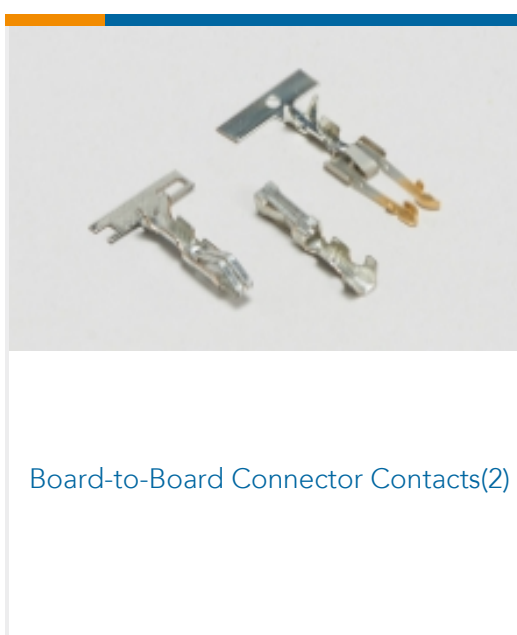
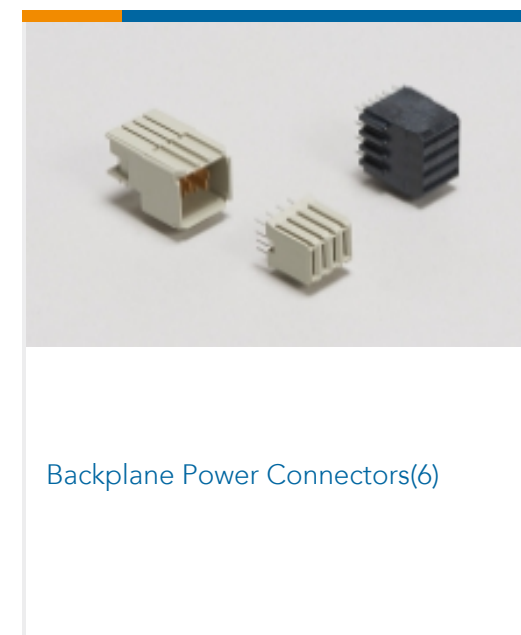
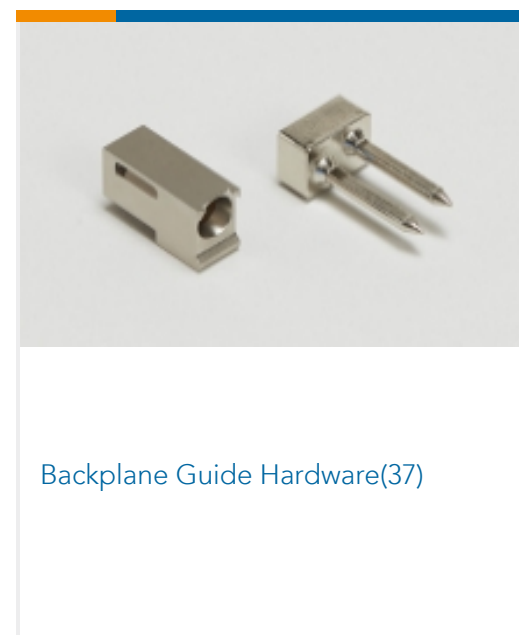
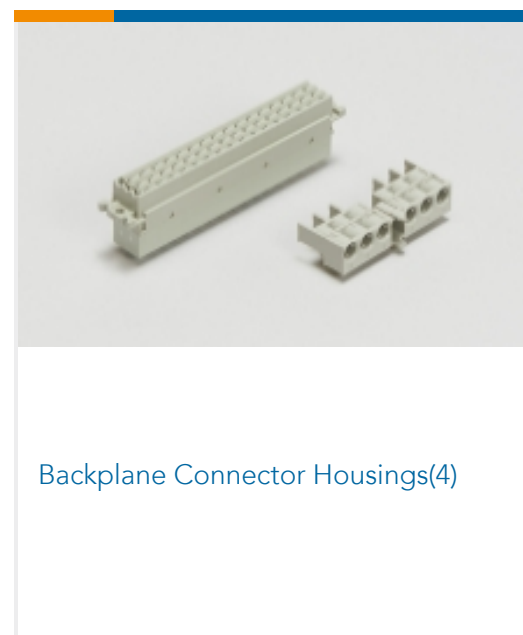
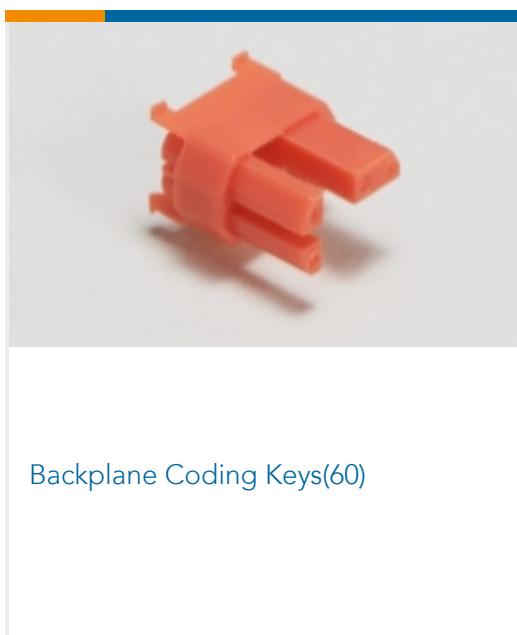

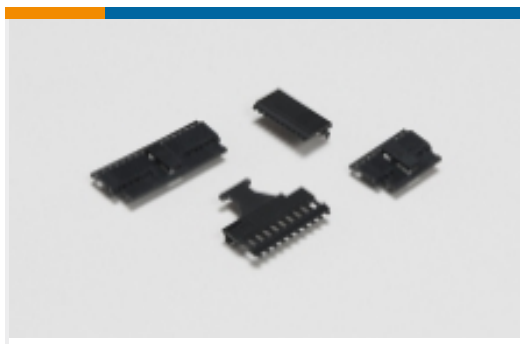

PCB Connector Covers(4)



PCB Connector Shrouds(39)



PCB Ferrules & Shields(19)



Rectangular Power Connectors(87)

Documents

Product Drawings

Z-PACK M.CODING KEY

English

CAD Files

3D PDF

3D

Customer View Model

[ENG_CVM_CVM_5-100525-9_C.2d_dxf.zip](#)

English

Customer View Model

[ENG_CVM_CVM_5-100525-9_C.3d_igs.zip](#)

English

Customer View Model

[ENG_CVM_CVM_5-100525-9_C.3d_stp.zip](#)

English

By downloading the CAD file I accept and agree to the [Terms and Conditions](#) of use.

Product Specifications

Application Specification

English

Product Environmental Compliance

TE Material Declaration

English